

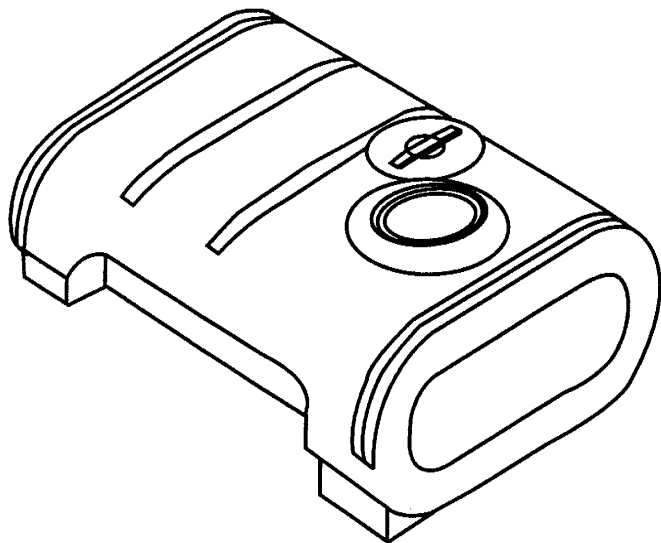

QUALITY MOLDED PLASTICS. LTD

Group Box 280 RR#4 * 71 St. Rd. & Highway 16 W * Saskatoon, SK S7K 3J7 * Phone: (306) 242-4494, Fax: (306) 242-4122

FLAT OVAL TRUCK MOUNT TANK



Top view

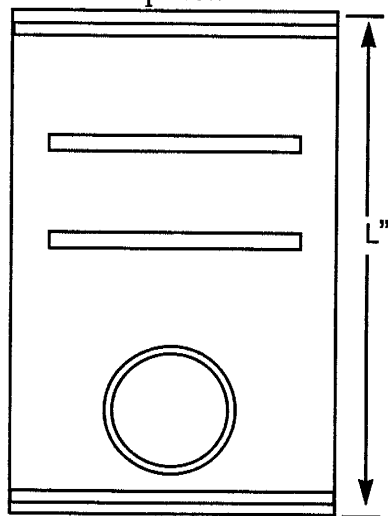

Front view

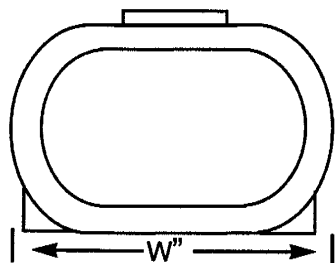

VOLUME		DIMENSIONS		
IMP. GAL	US GAL.	W"	L"	H"
420	504	56	72	32

- Linear low density (0.938), UV protected, food safe, polyethylene material in natural white; custom colours and materials available in quantity orders
- Mold-in wheel well openings to fit standard long and short 1/2 ton and 3/4 ton truck boxes
- Low profile allows for some rear visibility
- Manhole opening allows for 16" thread or flip-up lid. Other fittings available as required

Side view

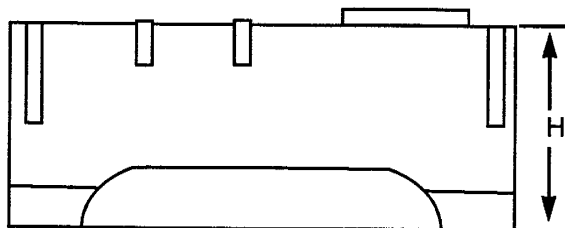



QUALITY MOLDED PLASTICS LTD.

Group Box 280 RR#4 * 71 St. Rd. & Highway 16 W * Saskatoon, SK S7K 3J7 * Phone: (306) 242-4494, Fax: (306) 242-4122

FLAT OVAL

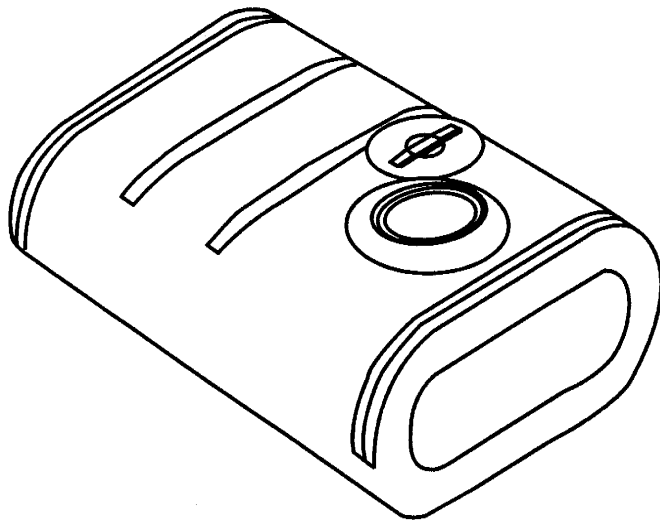

VOLUME		DIMENSIONS		
IMP. GAL	US GAL.	W"	L"	H"
420	504	56	72	32

- Linear low density (0.938), UV protected food safe, polyethylene material in natural white; custom colours and materials available in quantity orders
- Opening for 16" lid
- Front and rear volume calibration markings
- Mount strap indentations
- Drain sump 11" dia. x 4" deep

Top view

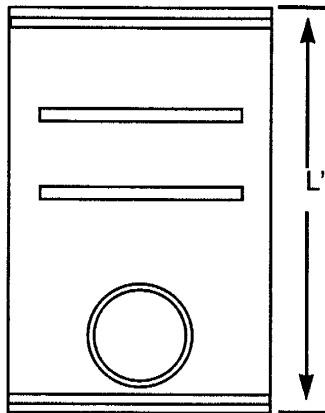

Front view

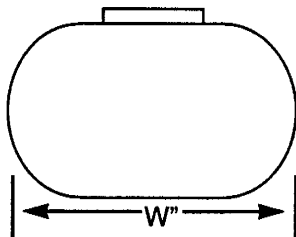

Side view

